

BRUGERMANUAL (DK) INSTRUCTIONS FOR USE (EN)

Wini: Grebsforstørrer / grip enlarger

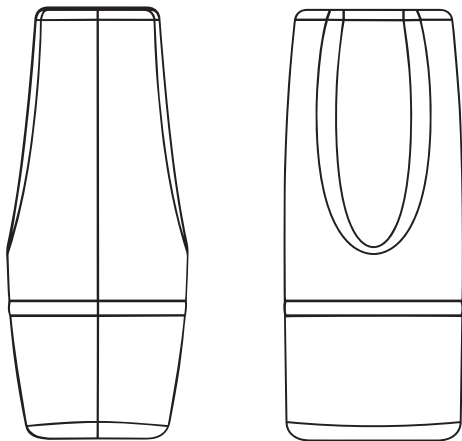

CONTENT

Brugermanual – Dansk **3**

| | |
|------------------------|---|
| Vigtigt | 3 |
| Wini | 4 |
| Om Wini | 5 |
| Produkt identifikation | 6 |
| Teknisk data | 7 |
| Misbrug/advarsler | 8 |
| Sådan bruger du Wini | 9 |

Instructions for use – English **13**

| | |
|------------------------|----|
| Important | 13 |
| Wini | 14 |
| About Wini | 15 |
| Product identification | 16 |
| Technical data | 17 |
| Misuse/warnings | 18 |
| How to use Wini | 19 |

Denne brugermanual indeholder vigtige sikkerhedsinstruktioner og information vedrørende brug af Wini.



Dette symbol indikerer vigtig information relateret til sikkerhed. Følg disse instruktioner varsomt.



Læs brugermanualen før brug! Wini er simpel at bruge, men læs brugervejledningen ordentligt igennem for at lære hvordan du bruger produktet korrekt.

Besøg www.manigrip.dk for at være sikker på at du har den nyeste udgave af brugermanualen.

Greb

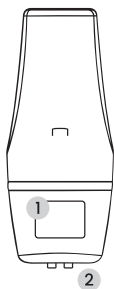

Cover

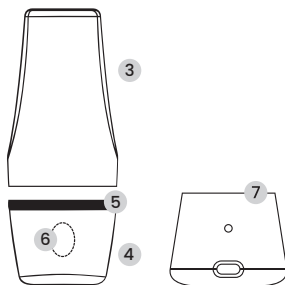
**Dele**

1. Knap
2. Opladningsstifter
3. Coverdel 1
4. Coverdel 2
5. Silikone ring
6. Knap
7. Opladningsstation

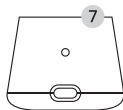
**CE deklarerering**

Produktet, og det dertilhørende tilbehør, beskrevet i denne brugermanual er i overensstemmelse med reguleringen (EU) 2017/745 af den 25. oktober 2022, som et medicinsk udstyr klasse 1.

CE

MD

Alle seriøse hændelser som sker i relation til produktet skal rapporteres til producenten og den kompetente myndighed i den medlemsstat, hvor brugeren og/eller patienten er bosiddende i.

Wini er et alsidigt hjælpemiddel, som kan bruges til at forstørre gribeflader på smalle hverdagsgenstande såsom bestik, pensler, hæklenåle, skriveredskaber, tandbørster etc. Den fleksible lukkemekanisme giver mulighed for, at du kan bruge Wini på mange forskellige genstande – vær kreativ!

Wini er skabt i samarbejde med gigtramte og ergoterapeuter. Indsigter fra mere end 120 patienter har vist et behov for hjælpemidler, der er fleksible, funktionelle og æstetiske. Alt dette har været i fokus under skabelsen af Wini. Wini er opkaldt efter den første patient som delte sin historie med Manigrip.

Besøg manigrip.dk for flere tips og tricks.

Tilsigtet formål:

Wini er et håndholdt hjælpemiddel for manipulation af håndredskaber, brugt til at facilitere greb om hverdagsgenstande for mennesker med nedsat håndfunktion.

Tilsigtet målgruppe og miljø:

Wini kan bruges af mennesker med nedsat håndfunktion. Produktet kan være brugbart for mennesker med gig, sclerose, nerveskader, rygmarvsskader, af ældre eller mennesker med lidelser som kan påvirke håndfunktionen.

PRODUKT IDENTIFIKATION

DK

Produktmærkets stregkode indeholder serienummer og produktionsdato:

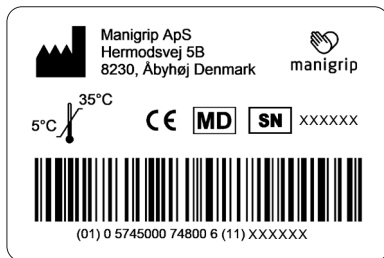

SYMBOLFORKLARING



CE-mærket



Producent



Smid ikke i restaffald



Serienummer



Medicinsk udstyr



Brugermanual

TEKNISK DATA

DK

| | |
|--------------------------------|---|
| Materialer: | Plastik, silikone |
| Batterikapacitet: | 150 mAh |
| Lukke-/åbningscyklus: | Lukke- og åbningscyklus afhænger af størrelsen på genstanden og varierer fra 2-5 sekunder. |
| Opladningstid: | 60 min. |
| Vægt: | 114 g. pr. greb |
| Indtrængningsbeskyttelse (IP): | Beskyttet fra nedsænkning på mellem 15 cm og 1 meters dybde. |
| Temperatur for benyttelse: | -10 ~ + 60°C |
| Temperatur for opbevaring: | -45 ~ 60°C, 60% RH: 1 måned 25 ~ 45°C, 60% RH: 3 måneder -20 ~ 25°C, 60% RH: 12 måneder Opbevaring i 50% opladet tilstand. |

DIMENSIONER

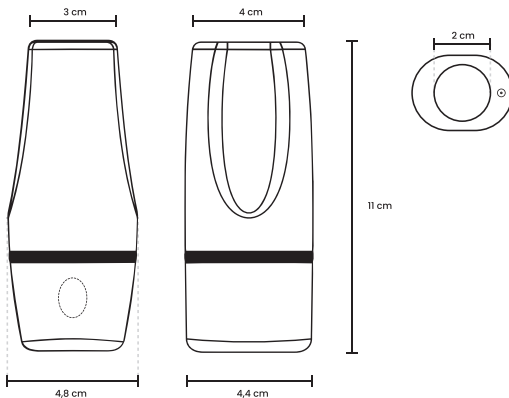



Tryk ikke på knappen uden at der er en genstand i grebet. Dette vil mindske levetiden på Wini.



Rengør ikke grebet i en opvaskemaskine – kun coveret.



Oplad ikke Wini mens grebet er vådt. Vær sikker på at det er helt tørt før du sætter grebet i opladningsstationen.



Put ikke kropsdele i grebet.



Sæt ikke skarpe genstande gennem grebet, da det kan skade funktionen. Indsæt altid skarpe genstande som f.eks. knive, med håndtaget først.

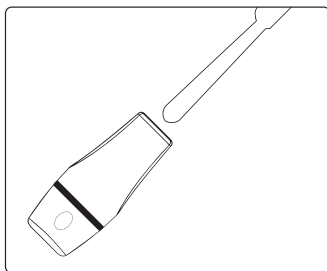
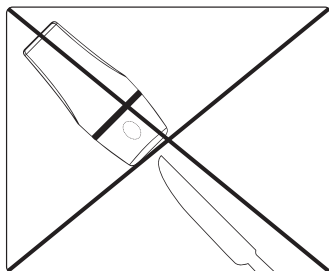

Før brug

Det er nemt at komme i gang, men vær sikker på at du har læst instruktionerne ordentligt igennem, rengjort produktet og ladet grebet fuldt op (se side 10-11)

Funktion

Indsæt genstanden, som du vil have en større gribeflade på, ind i grebet og tryk på knappen. Knappen vil aktivere lukkemekanismen og automatisk fastholde genstanden. Tryk på knappen igen og grebet giver slip på genstanden.

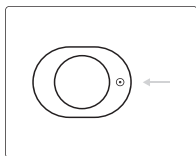
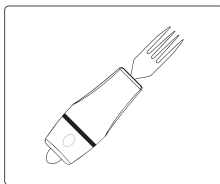
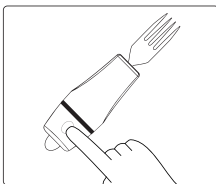
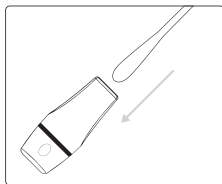

OBS: Genstanden kan rotere en smule. Brug den runde markør som en indikator for at lære hvordan genstanden skal positioneres for at få den rigtige vinkel.

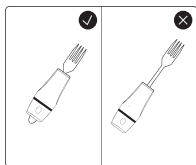

OBS: For at få det mest stabile hold på genstanden, anbefales det at sætte genstanden i grebet, således at den stikker jævnt ud i begge ender, som vist på illustrationen.

OPLADNING OG INDIKATIONER

DK

Hvis knappen på Wini blinker rødt, når du trykker på den, er grebet ved at løbe tør for strøm.

For at starte opladning skal du fjerne coverdel 2 og placere grebet i opladningsstationen. Sørg for at opladningsstationen er tilsluttet et USB-C kabel. Opladestationen vil blinke grønt, hvilket indikerer at grebet er begyndt at oplade. Når opladningsstationen lyser konstant grønt, i stedet for at blinke, er grebet fuldt opladet. Opladningstiden er ca. 1 time.

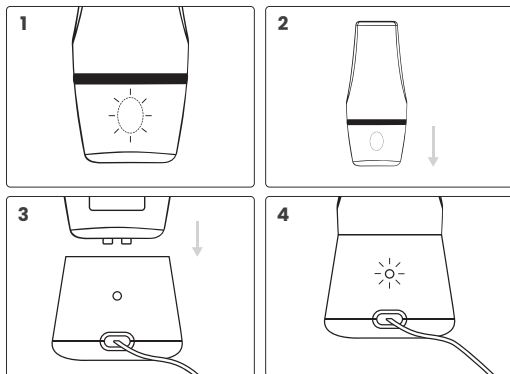

Lysindikationer

| | |
|---|--------------|
| Blinker rød | 10% batteri |
| Blinker grøn (sat i opladningsstationen) | Oplader |
| Konstant grøn (sat i opladningsstationen) | 100% batteri |

Rengøring af cover

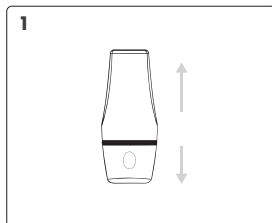

Fjern coveret fra grebet ved at trække de to coverdele fra hinanden. Drej eventuelt coverdelene en lille smule imens du trækker dem fra hinanden, hvis de er svære at tage af.

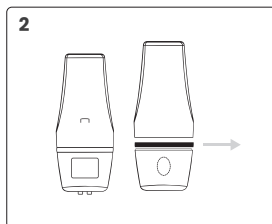

Fjern silikoneringsen fra coveret.



Rens coveret i enten en opvaskemaskine eller i hånden.

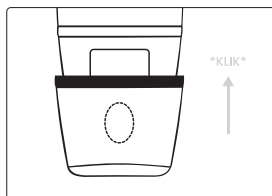

Sæt silikoneringsen tilbage på coveret efter rengøring og klik coveret tilbage på. **OBS:** vær sikker på at knappen på coveret og grebet overlapper hinanden.

Rengøring af greb

Rengør det ydre af grebet med en fugtig klud.

Det indre kan renses med en fugtig klud, flaskerenser eller andet blødt som kan være i åbningen. Rens ikke silikoneåbningen med drøje rengøringsmidler. Brug kun vand eller en mild sæbeblanding for at rense åbningen.

This User Manual contains important safety instructions and information regarding the use of Wini.



This symbol indicates important information related to safety. Follow these instructions carefully.



Read User Manual before use!
Wini is simple to use, but please read through the User Manual to learn how to use the device correctly.

Visit www.manigrip.dk to ensure you have the latest User Manual.

Handle

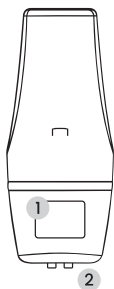

Cover

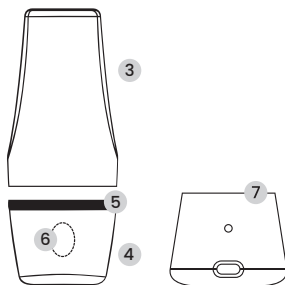
**Parts**

1. Button
2. Charging pins
3. Cover piece 1
4. Cover piece 2
5. Silicone ring
6. Button
7. Docking station

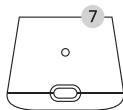
**CE declaration**

The product, and its related accessories, described in this user manual, is in compliance with the regulation (EU) 2017/745 of 25th October 2022 – as a medical device, risk class I.

CE



Any serious incident that occurs in relation to the device should be reported to the manufacturer and the competent authority of the Member State in which the user and/or patient is established.

Wini is a versatile aid device that can be used to enlarge the gripping surface of small everyday objects such as cutlery, paint brushes, crochet hooks, pens, toothbrushes etc. The flexible closing mechanism inside the device allows you to try out lots of different objects – be creative!

Wini is co-created with arthritis sufferers and occupational therapists. Insights from more than 120 patients has shown the desire to have aid devices that are flexible, functional and aesthetic, all of which has been a focus point in designing Wini. Wini is furthermore named after the first patient, who shared their insights with Manigrip.

Visit manigrip.dk for more tips and tricks.

Intended purpose:

Wini is a hand-held grip aid device for hand instrument manipulation used to facilitate the gripping of articles of daily use for people with restricted mobility of the hands.

Intended target group and environment:

Wini can be used by people with restricted mobility of the hands. The device can be useful for people with; arthritis, multiple sclerosis, nerve damage, spinal cord injuries, elderly or other illnesses that affect the mobility of the hands. The device can be used in the home, on the go and in a professional environment.

PRODUCT IDENTIFICATION

EN

The Product label's barcode contain serial number and production date:

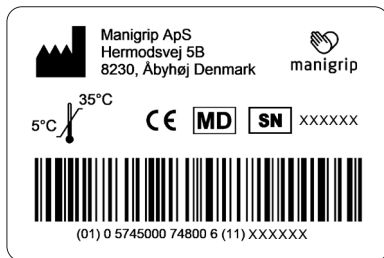

SYMBOLS



CE-marked



Manufacturer



Do not dispose in
general waste



Serial number



Medical Device



Read the user manual

TECHNICAL DATA

EN

| | |
|----------------------------|---|
| Materials: | Plastic, silicone |
| Battery capacity: | 150 mAh |
| Closing/opening cycle: | Closing/opening cycle depends on the size of the objects and varies from 2-5 seconds. |
| Charging time: | 60 min. |
| Weight: | 114 g. pr. handle |
| Ingress protection (IP): | Protected from immersion between 15 centimetres and 1 metre in depth. |
| Temperature for operating: | -10 ~ + 60°C |
| Temperatur for storing: | -45 ~ 60°C, 60% RH: 1 måned 25 ~ 45°C, 60% RH: 3 måneder -20 ~ 25°C, 60% RH: 12 måneder Opbevaring i 50% opladet tilstand. |

DIMENSIONS

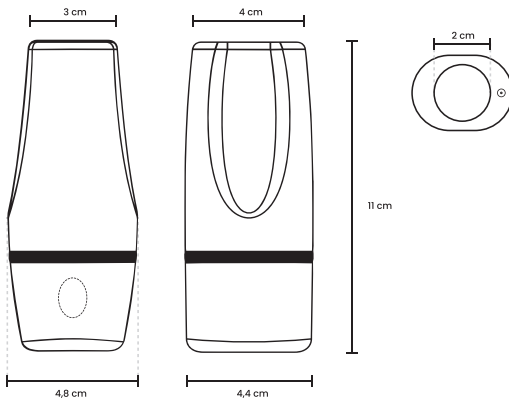



Don't press the button, without an object inserted into the handle. It will decrease the expected lifetime of Wini.



Do not clean the handle in the dishwasher, only the covers.



Don't charge the handle while wet. Make sure it is completely dry before inserting the handle into the docking station.



Don't insert bodily parts in the handle.



Don't put sharp objects through the handle, it can damage the function. Instead insert objects such as knives, handle first.

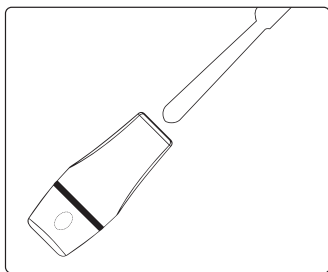
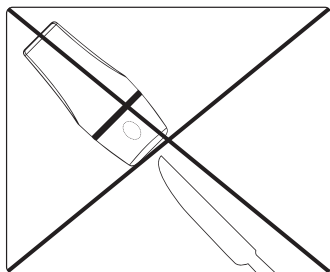

Before use

It is easy to get started, but make sure to read through the instructions, clean the handle and charge the handle completely (see page 20-21)

Function

Insert the object you want to get a larger surface of into the handle, and press the button. The button will activate the closing mechanism and automatically hold on to the object. Press the button again and the handle will let go of the object.

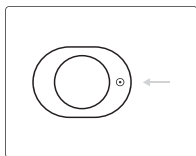
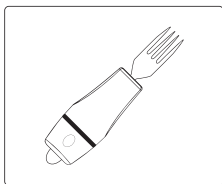
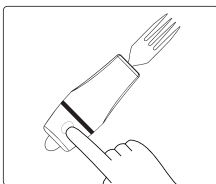
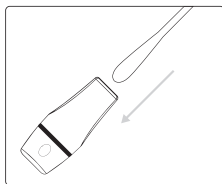

NOTE: The object may rotate slightly. Use the round mark as an indicator, to learn how to position the object to achieve the desired angle.

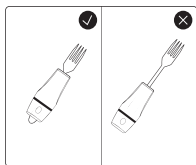

NOTE: To get the most stable hold on the object, place the object so it sticks out as evenly as possible in both ends as shown in the illustration.

CHARGING AND INDICATIONS

EN

Wini is low on battery when you see a flashing red light, while pressing the button.

To start charging, remove cover piece 2 and place the handle in the docking station. Make sure the docking station is plugged into a USB-C cable. You will see a green flashing light, that indicates the handle is charging. When the handle is fully charged the green light will switch to constant green.

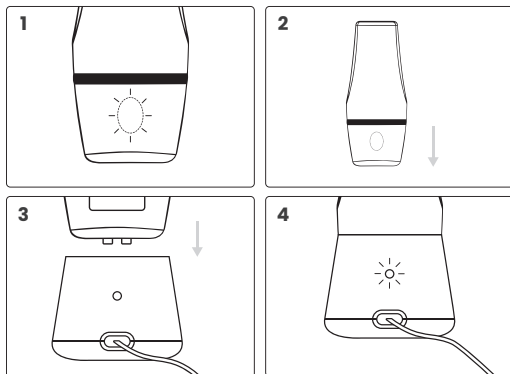

Light indications

| | |
|--|--------------|
| Flashing red | 10% battery |
| Flashing green (inserted in docking station) | Charging |
| Constant green (inserted in docking station) | 100% battery |

Cleaning of cover

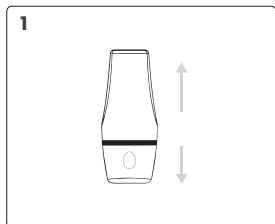

Remove the cover from the handle, by pulling apart the two cover pieces. If it is hard to remove, give it a light twist.

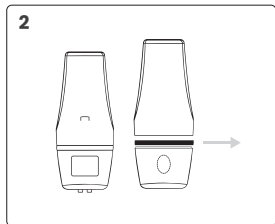

Remove the silicone ring from the cover.



Clean the cover in either the dishwasher or by hand.

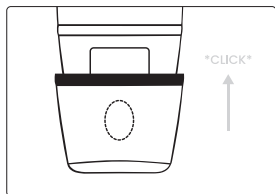

Put the silicone ring back on the cover after cleaning, and click the cover back on. **NOTE:** Make sure the buttons from both the handle and cover overlap.

Cleaning of handle

Clean the outside with a damp cloth.

The inside can be cleaned with a damp cloth, pipe cleanser or anything soft that fits in the opening. Do not clean the silicone tube with harsh detergents. Only use water or very mild soap to clean the inner tube.



manigrip



Manigrip ApS
Hermodsvvej 5B
DK-8230 Åbyhøj
www.manigrip.dk

